

# ELSAFE INDIA

Leading The Way To Safety  
Cochin - Chennai - Bangaluru - Hyderabad - UAE

www.elsafeindia.com, info@elsafeindia.com  
CALL US AT 0484-2575199, 08848281812

CALL US AT  
8848281812



## QUOTATION

Project Name: LSG ESE PKG  
Quote #: 24OQLSGP1  
Company: Residential-Protection



These are Residential Packages for Houses at Kerala State only, ALL KERALA FREE DELIVERY, NO HIDDEN CHARGES

Revision:  
Terms: \*\*\*  
Ship via: Land Cargo  
FOB: Ex-Factory  
Weight: \*\*\* As applicable

### LSG Protect-TGD30

Supply of External Lightning Protection System LSG PROTECT – Thunderguard® ESEs are made of non-corrosive materials, utilize advance and sustainable technologies, maintain a 15 Yrs warranty, are independently tested certified to NFC 17102 and UNE 21186 standards. Level IV 75 mtrs by capturing dangerous lightning discharges and safely channelling it to earth. All mounting mast connected with FRP mast for Protection of Side Flash Lightning Current and Test link Joint Kit IP 55/65 weather proof enclosure for testing the earth pit. Insulation material used to electrically isolate the panels, The lightning air terminal is maintenance free type & frequent testing is not necessary for ensuring the working of it. The central finial shall be elevated above the spheroid and it is sharp pointed & made-up of stainless steel alloy for long and reliable operations. An air gap provided between the individual electrically isolated 4 panels and the finial tip of the central rod.

Number	Item	Description	Qty.	Unit	Unit Cost	Total Cost
<b>Lightning Protection System</b>					(in INR)	(in INR)
1	ThunderGuard 30	LSG ThunderGuard 30 Lightning Arrester with SS ADAPTOR	1	No	INR 51,400	INR 51,400
2	Earthing	Maintenance free Earthing For Lightning Arrester: Using 2 no's of 2 Mtr long / 250 micron, 14.2mm Dia DOLPHIN UL Listed Copper bonded Steel Rod & TEKSO ELECTRON Fill , a low resistivity ,RoHS certified & Maintenance free Grounding Enhancement backfill Compound Model:-TEKSO ELECTRON FILL(22 kg)	1	Set	INR 12,000	INR 12,000
3	Elevation Mast	Specially designed 3 mtrs GI mast Setting , and 1 mtr FRP top section insulation mast; Roof top/Tower side mounting arrangement & fixing accessories (anchoring rope & anchoring plate, Base -for roof top installation). The mast coated with paint for additional protection,Cable connector Adaptor	1	Set	INR 8,000	INR 8,000
4	Down Conductor	50 Sq MM V Guard HRFR Insulated Copper Cable with tester cables for ESE Lightnig Arrester tester	25	Mtrs	INR 700	INR 17,500
5	Surge Protector Device	LSG Protect BC50 Imported 3 Phase 1+2 Combicontrol 50KA AC Surge protection device	1	No	Complementary	Complementary
6	Installation	Installation of ESE Lightning Protection System, tester system, SPDs with Down conductor routing from the LA terminal to the earth pit. Earth termination, fixing & Backfilling	1	Job	INR 10,000	INR 10,000
<i>Quotation Valid For 20 days</i>			<b>GRAND TOTAL</b>			INR 98,900.00

**Terms & Conditions**

- 1 Price Landed at site
- 2 Customers Scope: Material safety will be customer scope after delivery
- 3 Approvals /Permission of work/storage of tools & equipment/safety etc : At customers scope

*Thank you,*

**Best Regards**

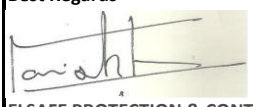

ELSAFE PROTECTION & CONTROL SYSTEMS

**CALL US AT 08848281812**



Doc. No. : **ES252612121**

Rev. No. :

Rev. Date :

*Sales and Service Provider of ALLTEC USA / LSG FRANCE/ TEKSAI-INDIA, Lightning Arresters, Surge Arresters, Maintenance free Earthing*



# CATALOGUE

**LIGHTNING -SURGE PROTECTION  
EARTHING & BONDING**

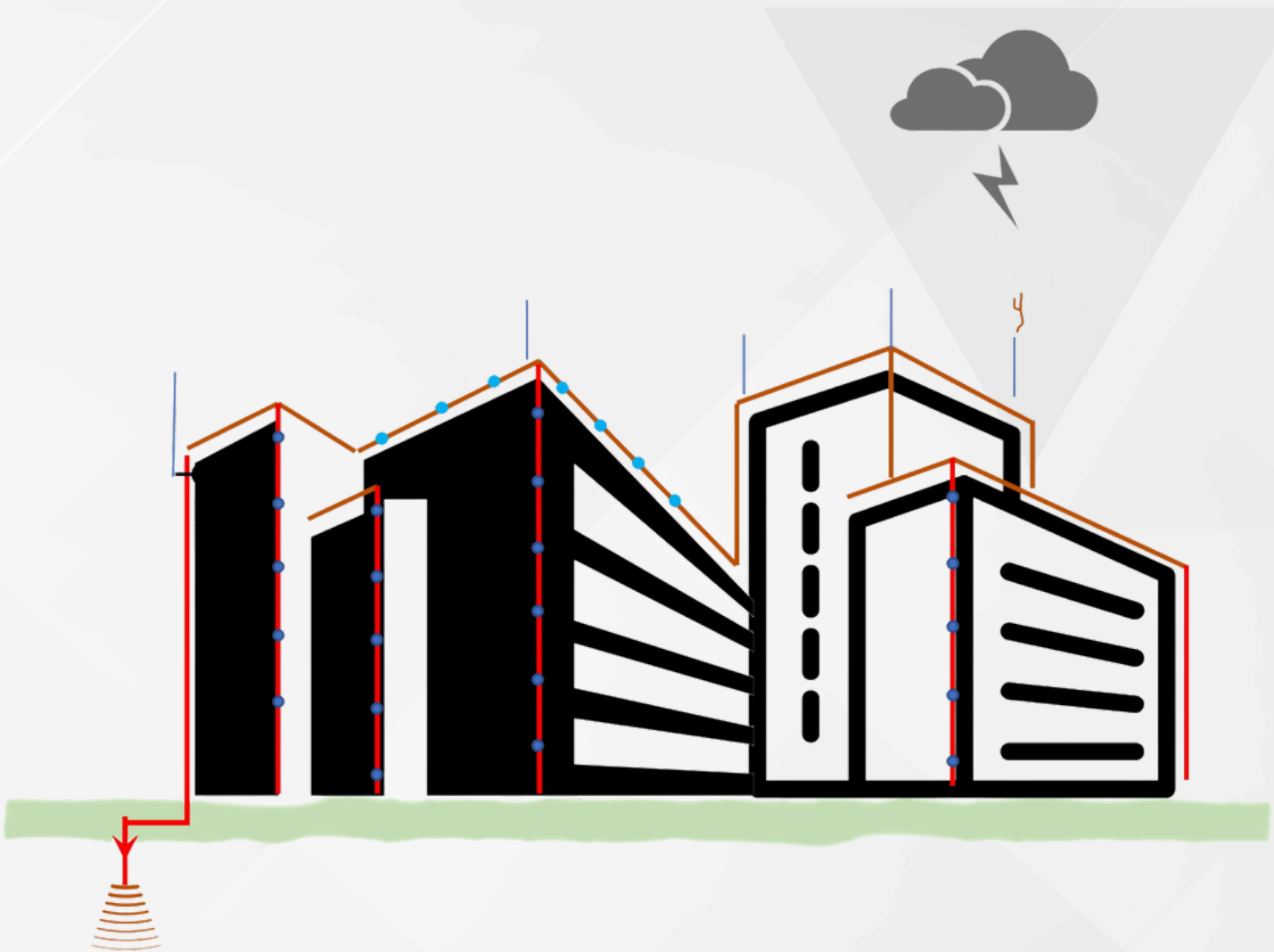

## About us

We **ELSAFE PROTECTION AND CONTROL SYSTEMS** is a renowned company specialized towards enduring electrical safety cultures across a wide range of markets. We specialize in a total electrical safety model which includes Quality lightning protection system, surge protection system, low resistivity Chemical earthing.



## Our brands



### ALLTEC USA

ALLTEC USA is an international, full-service company specializing in customized design & engineering solutions for grounding/earthing & bonding, surge/transient protection, and lightning protection.

### LSG FRANCE

LSG is a specialist company, in the fields of lightning protection, electrical earthing and surge protection. which grow the business through dynamic technical orientation and exceptional customer service

### TEKSAI INDIA

TEKSAI is an ISO 9001-2023 certified company and a leading brand in India Since 2003 & Tekesai has proven itself leader in the Design, Manufacturing of Grounding System, Lightning Protection System & Electrical installation

## Our Certifications



**RDSO**  
Research Design & Standards Organisation



## Our Products

01

**ESE LIGHTNING ARRESTERS**

02

**CONVENTIONAL LIGHTNING ARRESTERS**

03

**SURGE ARRESTERS**

04

**EARTHING RODS , ELECTRODES AND  
EARTH COMPOUNDS**

05

**COPPER/GI/ALUMINIUM STRIPS,  
CONDUCTORS, CABLES**

06

**EXOTHERMIC WELDING**

## Our services

01

**PRODUCT SALES**

Our Stock management and Our Supply chain management is well appointed and best managed to Provide best customer experience and timely completion of Orders.

02

**SITE VISIT & DESIGN**

Understanding of the Site design, layout and their plan for electrical safety implementation all enable us to contribute efficiently; ensuring total Protection and Solution level is achieved

03

**INSTALLATION**

Our installation crews and field technicians perform all forms of exterior earth grounding and internal equipment bonding and grounding, including comprehensive turnkey installation service. Employees participate in continuing education and advancement courses and are ALLTEC Certified Master Installers.

04

**TESTING AND SUPPORT**

Our field technicians and engineers perform 3-point fall of potential tests, 4-point soil resistivity tests, and clamp-on resistance tests of grounding systems, as well as complete facility site survey and consulting services. Our staff is equipped with the latest testing equipment. Extensive experience in ground testing and design



भारतीय प्रौद्योगिकी संस्थान हैदराबाद  
Indian Institute of Technology Hyderabad





# ALLTEC



## CONVENTIONAL LIGHTNING PROTECTION





# ALLTEC



## ESE LIGHTNING PROTECTION







LSG PROTECT<sup>®</sup>



## SURGE PROTECTION DEVICES







**LSG PROTECT**®



## ESE LIGHTNING PROTECTION





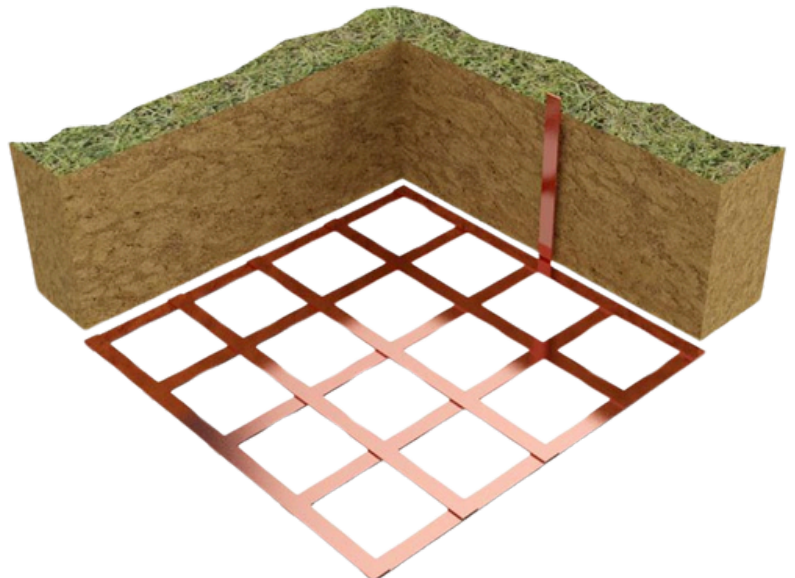
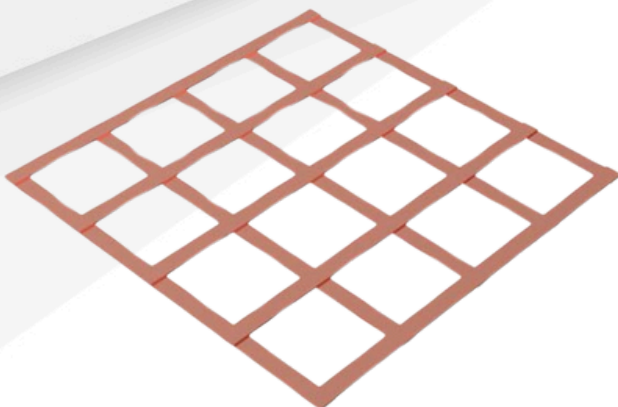
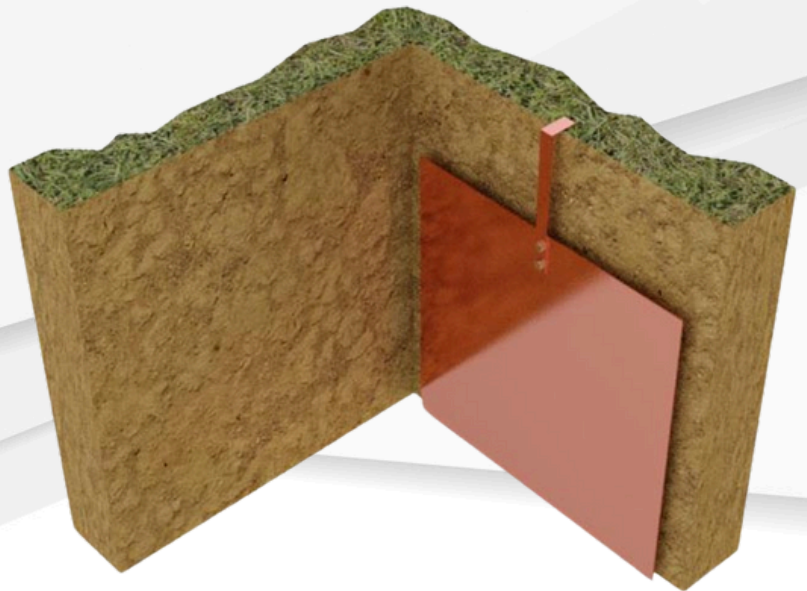
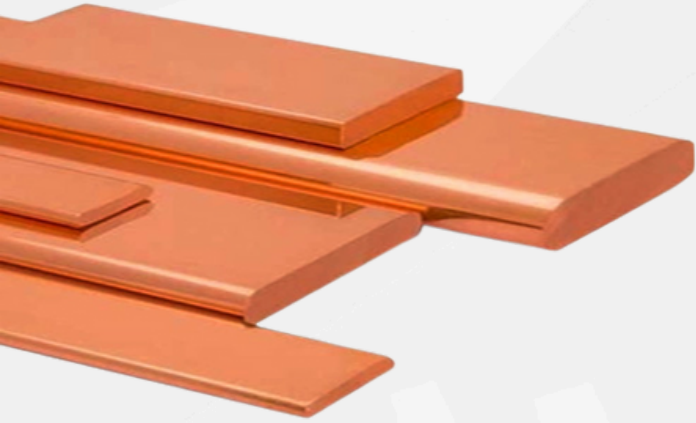



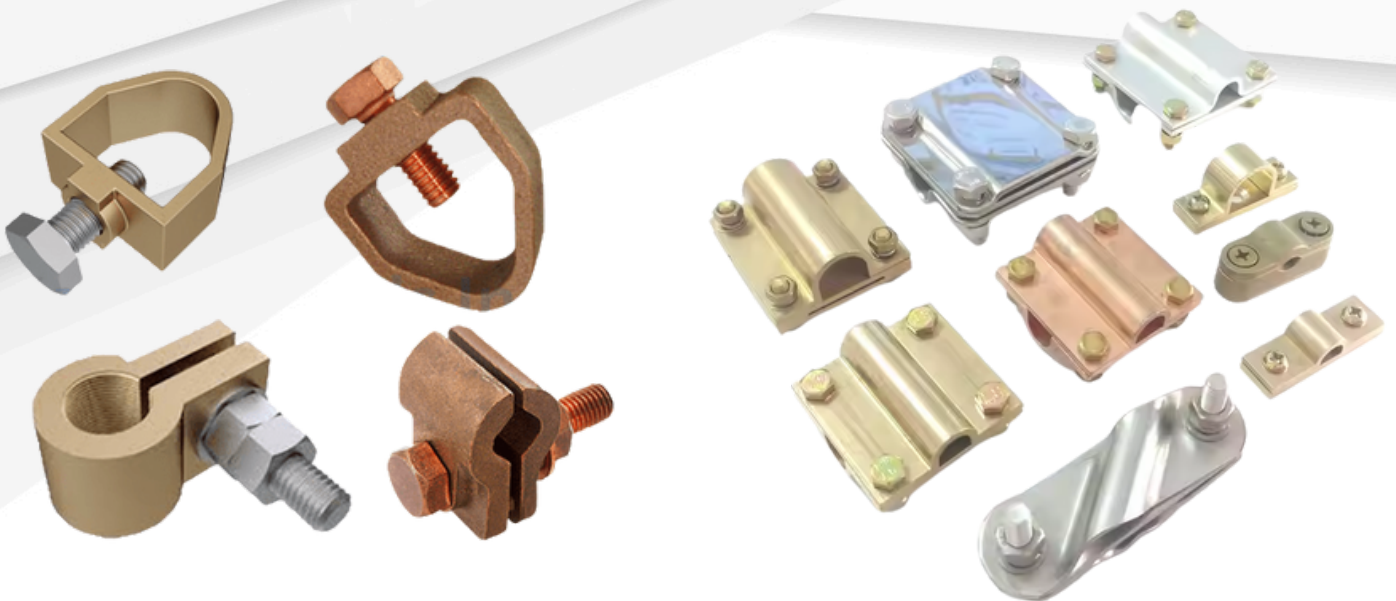

**EARTHING SOLUTIONS**



# COPPER/GI/ALUMINIUM CONDUCTORS







# CONTACT



[www.elsafeindia.com](http://www.elsafeindia.com)

[info@elsafeindia.com](mailto:info@elsafeindia.com)

+91-484-2575199, 8848281812

Elsafe Garden, West Morakkala, Kumarapuram  
PO, Kakkanad, Ernakulam-683565  
Kerala State, India



**THUNDER GUARD®**



**LSG PROTECT®**



## ESE LIGHTNING ARRESTERS

### THUNDER GUARD

ThunderGuard series ESE Lightning Arresters Developed and designed in our highly advanced labs is specially designed with unique design philosophy as per NFC-French Standard.

Thunderguard adopts synthesis techniques of leader discharge, impedance to limit current, air-gap discharge etc to produce leader channel in advance, improve lightning effect, reduce discharge voltage and change the discharge process of lightning current.

Thus it broaden the lightning wave, flatten the leading wave, decrease the amplitude and enlarge the scope of protection avoiding side striking and shielding failure then finally actively suppress the damage of Ground Potential Counter attack. Therefore it is an ideal device to prevent direct lightning.

ThunderGuard Series ESE lightning Arresters come in with widest Protection coverage area. Find Our protection radius coverage table for reference.



LSG THUNDERGUARD PROTECTION RADIUS			
	H(m)	ThunderGuard 30	ThunderGuard 60
LEVEL 1	2	20	32
	3	30	48
	4	40	65
	5	50	79
	6	50	79
	8	51	79
LEVEL 2	10	51	81
	2	23	38
	3	35	55
	4	47	74
	5	58	89
	6	58	90
LEVEL 3	8	59	92
	10	60	92
	2	27	42
	3	40	62
	4	53	82
	5	66	99
LEVEL 4	6	66	99
	8	68	101
	10	69	101
	2	30	45
	3	45	65
	4	59	87
LEVEL 4	5	74	108
	6	74	108
	8	76	110
	10	77	111



## ESE LIGHTNING ARRESTERS **THUNDER GUARD**

### Product Structure:

- Central bar
- Reflector
- Trigger gear
- Exciter
- Dead plate of exciter
- Trigger gear, reflector and central bar all are insulating
- Reflector and central bar show good electrical connection to the earth
- The base of exciter is made up of synthetic resin thus applicable to any corrosion environment



### Advantages:

- Non-electronic type, long life.
- Guaranteed electrical continuity and sustainability after repeated lightning strike.
- High radius of protection for user selection.
- Non-electrical system, will not be effected by surge impact.
- Only self-activated during lightning strike and initiative intervene the lightning protection system.

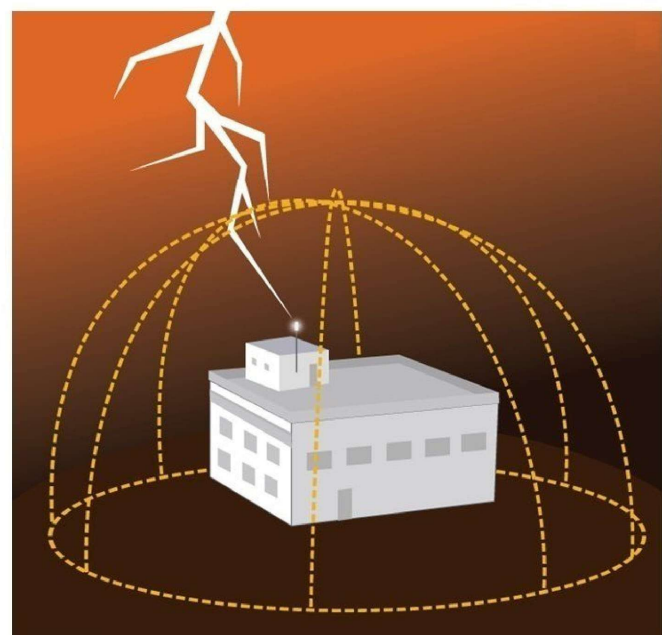

## ESE LIGHTNING ARRESTERS **THUNDER GUARD**

### Thunderguard 30

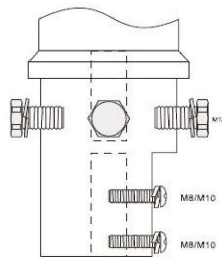
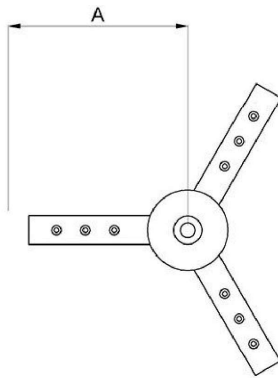
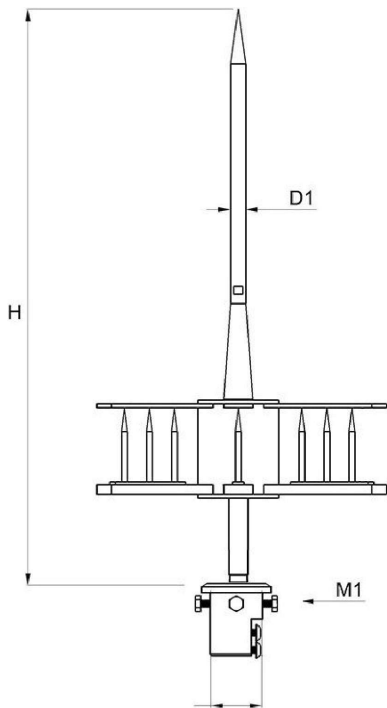

LSG TGD30<sup>®</sup> protection (UNE 21.186:2011, NFC 17.102:2011 and NP 4426:2013)

Content No	Material	Height (mm)	Dimension (mm)	Weight (mm)
232111	Stainless Steel	650	18	3700

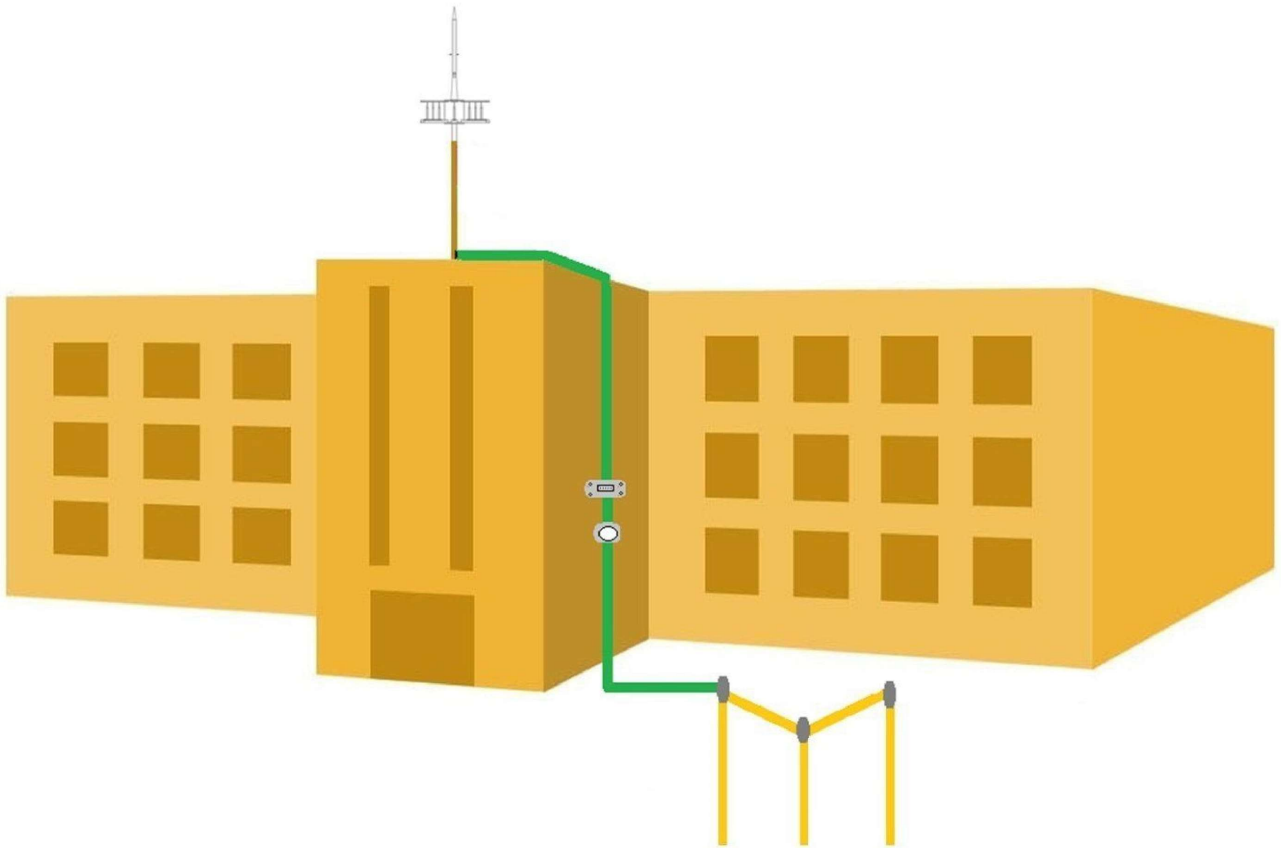

**LSG PROTECT**

No.1 avenue de Luxembourg, Europa tower, 94320 Thiais, France  
[www.lsgprotect.com](http://www.lsgprotect.com), [cs@lsgprotect.com](mailto:cs@lsgprotect.com)  
Contact No 0033-7-61-52-75-00